



Intelligent . Safe . Modular
Power the world with safe and clean energy



**Lithium Phosphate Energy Storage System
RD-51.2-100-SF Operation Manual**



Shenzhen Maweiou Technology Co., Ltd.

Address: Building 11, Changjing Artificial Intelligence Industrial Park, No. 3
Huachang Road, Langkou Community (the innermost one), Dalang Street,
Longhua District, Shenzhen City, Guangdong Province, China

Content

1. Safety	1
1.1 Important safety instructions.....	1
1.2 Skills of Qualified Personnel	1
1.3 Warnings in this Document.....	1
1.4 Battery handling guide	2
1.5 Response to emergency situations	2
1.5.1 Leaking batteries	2
1.5.2 Fire.....	2
1.5.3 Wet battery.....	2
1.5.4 Damaged battery	2
1.5.5 Battery Disposal.....	2
1.6 Customer careline.....	3
2. Product Introduction	3
2.1 System Parameter	3
2.2 Battery Module	4
2.2.1 Battery Module BMS functions.....	5
2.2.1.1 Voltage detection and protection function.....	5
2.2.1.2 Voltage detection and protection function.....	5
2.2.1.3 Temperature detection and protection function.....	5
2.2.1.4 Pre-charge function	5
2.2.1.5 Short circuit protection function.....	5
2.2.1.6 Reverse connection protection function.....	5
2.2.1.7 Battery Passive Balancing.....	5
2.2.1.8 Equalization function.....	5
2.2.1.9 Sleep and wake-up function	6
2.2.1.10 Charging current limiting function	6

2.2.2 Battery Module Over View	7
2.3 Battery Inverter.....	9
2.3.1 Battery Inverter Over View	9
2.3.2 AC Input/ Output Connection	11
2.3.3 PV Connection	11
3. Guidance for battery inspection upon reception	12
4. Installation Pre-requisites.....	12
4.1 Selection of installation sites.....	12
4.2 Tools.....	13
4.3 Personal protective equipment	13
4.4 Storage	13
5. Battery Installation.....	14
5.1 Package Items	14
5.2 Checks before installation	14
5.3 Installation of battery base.....	14
5.4 Battery Modules and Inverter Module pile up	15
5.5 Grounding	17
6. System Operations.....	17
6.1 Master Slave - Battery Dip Switches Configuration.....	17
6.1.1 Master Batteries Dip Switch Configuration.....	18
6.1.2 Slave Batteries Dip Switch Configuration.....	18
6.2 LED indication function	19
6.3 System turns on.....	20
6.4 System output mode	20
6.5 Battery charging	20
6.6 Battery inverter operation	21

1. Safety

HZF-51.2-100-SF is a low voltage Lithium-Ion Phosphate Battery storage system, operated by skilled/qualified personnel only. certain precautions must be observed when installing or operating the product. To reduce the risk of personal injury and ensure the safe installation and operation of the product, you must carefully read and follow all instructions, cautions and warnings in this manual. Any confusion, please contact Weida immediately for advice and clarification.

1.1 Important safety instructions

Incorrect operation or work may cause:

- Injury to the operator or a third party;
- Damage to the system hardware and other properties belonging to the operator or a third party.

1.2 Skills of Qualified Personnel

Qualified personnel must have the following skills:

- Training in the installation and commissioning of the electrical system, as well as the dealing with hazards;
- Knowledge of this manual and other related documents;
- Knowledge of the local regulations and directives.

1.3 Warnings in this Document

Symbol	Description
	Warning electric shock
	Danger
	Heavy enough may cause severe injure
	Read the product and operation manual before operating the battery system
	Do not place near open flame
	Do not place at the children and pet touchable area
	Recycling
	Do not dispose of the product with household waste
	Do not reverse connection the positive and negative

For safety reasons, installers are responsible for familiarizing themselves with the contents of this manual and all warnings before installation. Failure to do so may result in product damage or injuries.

1.4 Battery handling guide

Use the battery pack only as directed. Battery must be transported always with its top side up and never upside down or on its side.

1.5 Response to emergency situations

Lithium-Ion Phosphate Battery storage system is designed with multiple safety strategies to prevent hazards resulting from failures. However, a residual risk will always exist due to the nature of the product, and these must be considered at the time of system design and installation.

1.5.1 Leaking batteries

If the battery pack leaks electrolyte, avoid contact with the leaking liquid or gas. Electrolyte is corrosive and contact may cause skin irritation and chemical burns. If one is exposed to the leaked substance, do these actions:

Inhalation: Evacuate the contaminated area and seek medical attention immediately.

Eyes contact: Rinse eyes with flowing water for 15 minutes and seek medical attention immediately.

Skin contact: Wash the affected area thoroughly with soap and water and seek medical attention immediately.

Ingestion: Induce vomiting as soon as possible and seek medical attention immediately.

1.5.2 Fire

In case of fire, only dry powder fire extinguisher can be used, liquid fire extinguishers are prohibited.

WARNING

The battery pack may catch fire when heated above 130°C. If a fire breaks out where the battery is installed, do these actions.

- Extinguish the fire before the battery catches fire.
- If the battery has caught fire, do not try to extinguish the fire.
- Evacuate people immediately. If the battery catches fire, it will produce poisonous gases. Do not approach.

1.5.3 Wet battery

If the battery is wet or submerged in water, do not try to access it. Contact your distributor for technical assistance.

1.5.4 Damaged battery

If the battery is damaged, please contact your distributor for help as soon as possible. A damaged battery can be dangerous and must be handled with extreme caution. Damaged batteries are not suited for use and may pose a danger to people or property. If the battery seems to be damaged, return it to your distributor for inspection and assessment.

1.5.5 Battery Disposal

Please follow your local regulations regarding disposal or recycling of Lithium Batteries.

1.6 Customer careline

Use the contact below for technical assistance. This phone number is contactable only during business hours on weekdays.

Customer careline	+86-596-8369887
-------------------	-----------------

2. Product Introduction

2.1 System Parameter

Product Type	RD-51.2-100-SF		
Battery Type	LiFePO4		
Battery System Capacity(kWh)	10.24	15.36	20.48
Battery System Voltage(Vdc)	51.2		
Battery System Capacity(AH)	200Ah	300Ah	400Ah
Battery Inverter Name	HZPV-5048VHM		
Dimension[L*W*H](mm)	680*460*740	680*460*915	680*460*1090
Battery Module Quantity(pcs)	2	3	4
Net Weight (KG)	about 136KG	about 184KG	about 232KG
Battery Module Capacity(kWh)	5.12		
Battery Module Voltage(Vdc)	51.2		
BatteryModule Capacity(AH)	100		
Battery System Charge Upper Voltage(Vdc)	58.4		
Battery System Max continuous charge current (A)	50		
Battery System Max continuous Discharge current (A)	100		
Operating Temperature Range	Charge: 0~45°C ; Discharge: -20~50°C		
Discharging End-off Vol (Vdc)	42		
Communication	Canbus-Inverter; RS485-Parallel communication		
Limited Warranty(Years)	5 Yeays		
Operating Condition	Strictly Indoor		
Protective Class	IP20		

Product Type		RD-51.2-100-SF
Inverter Output	Rated Power	5000W
	AC Voltage Regulation (Batt.Mode)	(220VAC~240VAC)±5%
	Inverter Efficiency (Peak)	93%
	Transfer Time	10ms(UPS/VDE4105) 20ms(APL)
Inverter AC Input	Voltage	230VAC
	Frequency Range	50Hz /60Hz(Auto sensing)
Solar Charger & AC Charger	Number of MPPT	2
	PV Input Power	4500W*2
	Maximum PV Array Open Circuit Voltage	145VDC
	PV Array MPPT Voltage Range	60~130VDC
	Maximum Solar Charge Current	80A
	Maximum AC Charge Current	50A (230V)
Inverter dimension[L*W*H](mm)		680*460*240

2.2 Battery Module

Item	Description
Battery Type	LiFePO4
Nominal Battery Energy	5.12Kwh
Nominal Capacity	100Ah
Nominal Voltage	51.2V
Operating Voltage Range	42V~58.4V
Max continuous charge current	50A
Max continuous discharge current	100A
Net Weight	about 48.5KG
Dimension[L*W*H](mm)	680*460*175
Operating Temperature Range	Charge:0~45°C; Discharge:-20~50°C
Communication	CAN/RS485
Limited Warranty(Years)	5 Year

2.2.1 Battery Module BMS functions

2.2.1.1 Voltage detection and protection function

The BMS monitors individual cell voltages with over voltage and under voltage alarms and protections. Measurement accuracy is Cell Volts +/- 10mV. Cell imbalance Alarms and protections are built into the BMS software.

2.2.1.2 Voltage detection and protection function

Current measurement is built into the BMS circuit, charging current is displayed as positive current, and discharge current is displayed as negative current. The current sampling accuracy is rated at $\pm 2\%$ at room temperature. Alarms and protections for over current (Charge and Discharge) are built into the protection's logic.

2.2.1.3 Temperature detection and protection function

The battery BMS comes equipped with 4 temperature probes to monitor internal cell temperature, 1 environmental probe and 1 MOS probe. Alarms for Over Temperature and under temperature are part of the protection system.

Battery maximum charge and discharge currents are subject to temperature the BMS will reduce the current progressively down to 0 Amps in cold weather to protect the battery.

Temperature probes used are Thermistors 10K / 3435 / NTC with an accuracy of +/-2degC

2.2.1.4 Pre-charge function

The system is compatible with most modern inverters. In order to avoid damages to both the battery module and the inverters, the BMS is equipped with a pre-charge resistor. The pre-charge resistor will dampen the inrush currents when the battery is first connected to the inverter and the inverters charge their DC bus to a steady state voltage.

2.2.1.5 Short circuit protection function

Battery module comes equipped with short circuit detection. If POS and NEG terminals are shorted on the battery output (accidentally or due to inverter internal failure) the BMS will detect the short circuit condition and will open the Positive terminal output automatically. The ALM light (Alarm) will light up to indicate the fault condition. The BMS detects whether there is still an external short circuit every 60 seconds. If there is no short circuit, it will return to the standby state. If there is still a short circuit, it will continue to protect. After 5 continuous cycles of short circuit detection and recovery the battery will go onto a permanent fault state and will keep the output contactor open. After the short circuit is removed from the battery output circuit the battery can be manually brought to operation by pressing the SW pinhole switch until the battery resets the fault condition and closes the contactor again.

2.2.1.6 Reverse connection protection function

The battery module is equipped with automatic reverse polarity detection. The protection clears automatically as soon as the reverse polarity connection is removed/corrected.

2.2.1.7 Battery Passive Balancing

The battery module can perform passive cells voltage equalization. This function operates only during the charging cycle and allows the BMS to equalize battery cells exceeding by more than 15mV the average cell voltage values. Equalization is made possible via current recirculation in between cell pairs via the BMS equalization circuit. Alarms and protections for cell imbalance are present to protect the battery module in the event of battery cells degradation or failures.

2.2.1.8 Equalization function

Equalization function is available for battery bank rebalancing and SOC recalibration. This procedure is not a field procedure and shall always be conducted by a qualified technician. The equalization opening voltage can be adjusted by software. The setting range is 3.2V ~ 3.8V. The default opening voltage is 3.5V, the equalization current is $\geq 50\text{mA}$, for as long as equalization resistance temperature is not more than 50°C.

2.2.1.9 Sleep and wake-up function

A Sleep function is provided as part of the BMS programming, this protects the battery module to drain below the point at which the BMS could not operate and could require battery to be manually recharged at a repair center. In order to avoid these 3 sleep modes , please refer to the table below.

Condition	Operational condition	Wakeup condition	Wakeup Mode
1	Normal standby, no charge or discharge for over 48 hours	External power on voltage (36.0V - 56.4v), charging, reset button, soft switch.	SW Switch or restart Switch
2	The lowest cell voltage is lower than the Cell over discharge protection value or the total Group voltage is lower than the overall over discharge protection value. After 10 minutes of the condition been present battery module will enters under voltage sleep	External power on voltage (36.0V - 56.4v), charging, reset button, soft switch.	SW Switch or restart Switch

2.2.1.10 Charging current limiting function

The battery module BMS does perform charging current limiting as an integral function of integration with most inverters. There are two modes of current control automatically available: active current limiting and Protection current limiting, which are selected according to the demand and state of charge of the battery module.

Active current limiting: During normal battery charge the BMS monitors battery charge current and enables direct charging up to the maximum allowable for the prevailing state of charge. If the current exceeds the allowable current the active limiting, take place and current is reduced to 10amps by the active limiing circuit. In close loop control the Inverter reads the maximum charge current from the BMS and thus in theory charge limiting is not required although the function is always active in the background as a safety feature.

Protection current limiting: If the charging current reaches the charging over current alarm value (current setting 100A), the BMS current control is automatically set to 10A regardless of battery state of charge. After limiting the current for 5 minutes the BMS will release the current limiting and will verify if the charge current redetects whether the charge current reachesthe passive current limiting condition. If the current exceeds the limit the charge current limiting is re-enabled.

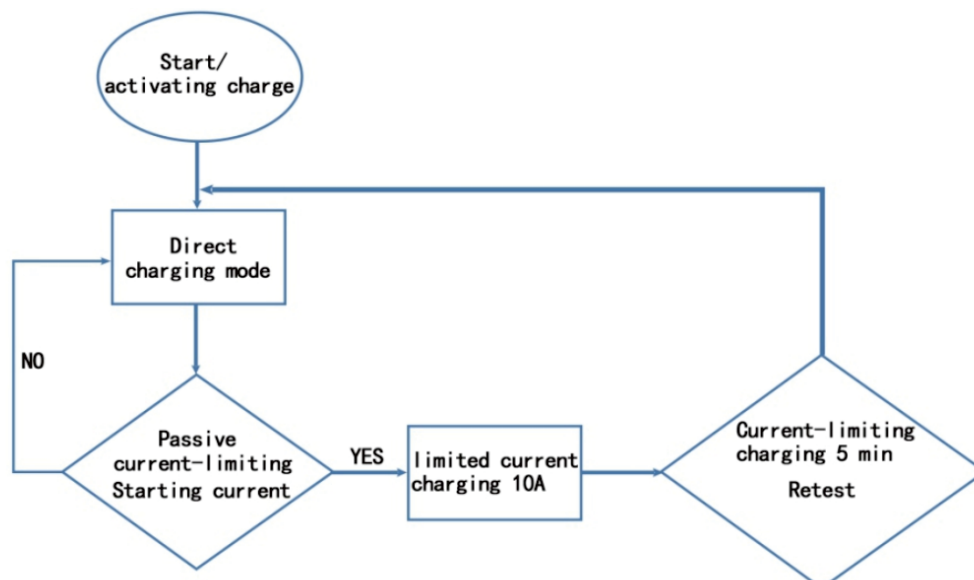

2.2.2 Battery Module Over View

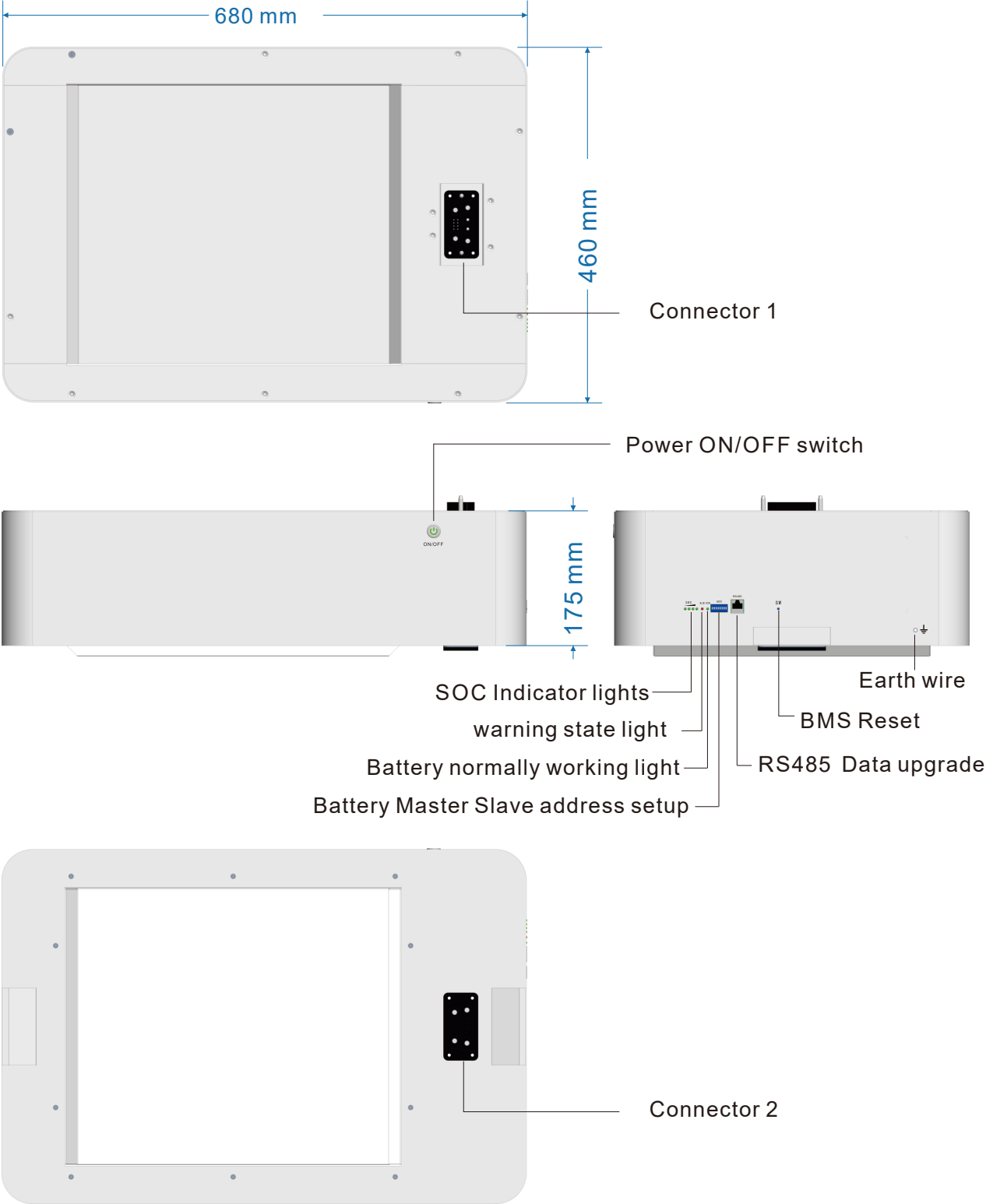

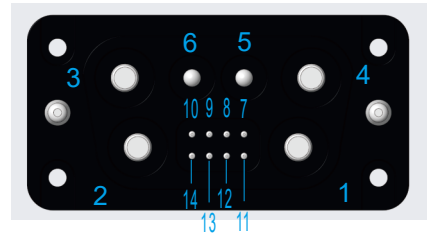

Connector 1			
Item	Definition	Item	Definition
1	Battery Positive +	8	(1)RS485-B
2	Battery Negative -	9	(2)RS485-A
3	Battery Negative -	10	(2)RS485-B
4	Battery Positive +	11	CAN-H
5	Empty	12	CAN-L
6	Empty	13	
7	(1)RS485-A	14	

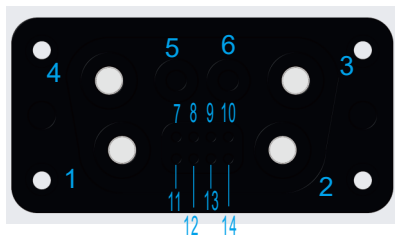

Connector 2			
Item	Definition	Item	Definition
1	Battery Positive +	8	(1)RS485-B
2	Battery Negative -	9	(2)RS485-A
3	Battery Negative -	10	(2)RS485-B
4	Battery Positive +	11	CAN-H
5	Empty	12	CAN-L
6	Empty	13	
7	(1)RS485-A	14	

2.3 Battery Inverter

2.3.1 Battery Inverter Over View



Wire guard



Open the wire guard

Terminal protection cover

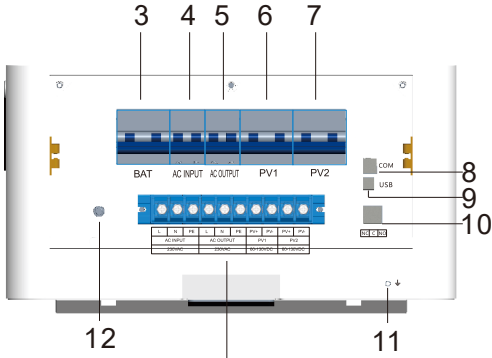
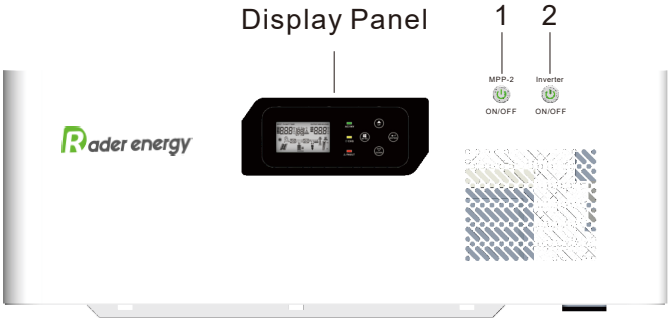

Connecting Terminal

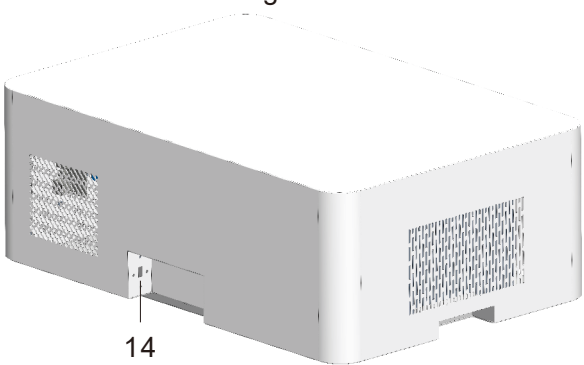
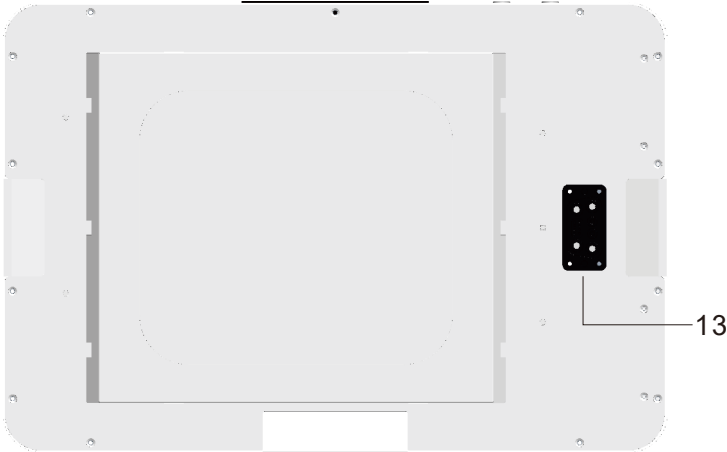

N0.	Definition	N0.	Definition
1	MPPT-2(PV2) Power ON/OFF switch	8	RS-485 Communication port
2	Inverter Power ON/OFF switch	9	USB
3	Battery circuit breaker	10	Dry contact
4	AC input circuit breaker	11	Earth wire
5	AC output circuit breaker	12	Inverter Circuit breaker
6	PV1 circuit breaker	13	Connector 2
7	PV2 circuit breaker	14	USB wifi

Back panel printing description

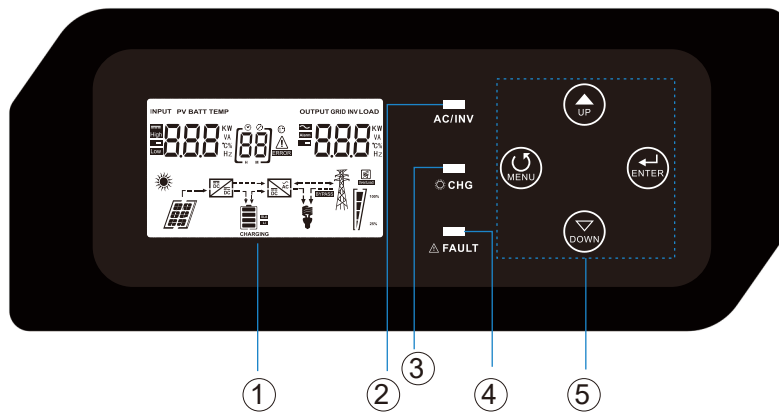

Display Panel	
N0.	Description
1	LCD Display
2	Status Indicator
3	Charging Indicator
4	Fault Indicator
5	Function Buttons

Connecting Terminal

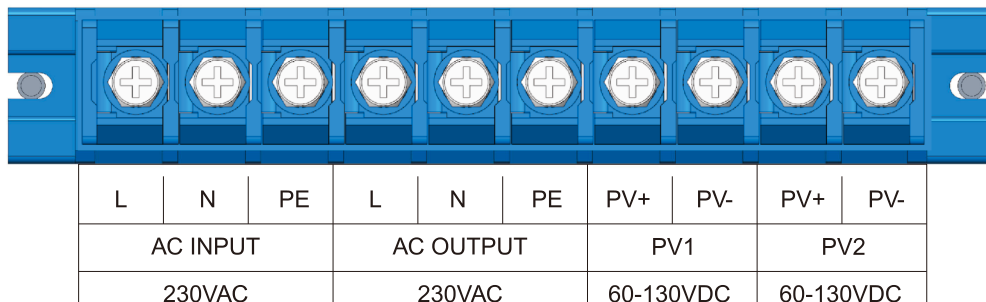

2.3.2 AC Input/ Output Connection

CAUTION: Before connecting the AC input power supply, please ensure that the AC input circuit breaker is disconnected

CAUTION! There are two terminal blocks with "IN" and "OUT" markings. Please do NOT-misconnect input and output connectors.

WARNING! All wiring must be performed by a qualified personnel.

WARNING! It's very important for system safety and efficient operation to use appropriate cable for AC input connection. To reduce risk of injury, please use the proper recommended cable size as below.

Suggested cable requirement for AC wires

Cable Size	Torque Value
8 AWG	1.4~1.6Nm

Please follow below steps to implement AC input/output connection:

1. Before making AC input/output connection, be sure to disconnect the circuit breaker.
2. Insert the AC input wire according to the indicated polarity and tighten the wire head screw. Be sure to connect PE protective conductor (\perp) first.
3. Then, insert the AC output wire according to the indicated polarity and tighten the terminal screws. Be sure to connect PE protective conductor (\perp) first.
4. Make sure the wires are securely connected.

WARNING:

1. Be sure to that AC power source is disconnected before attempting to hardwire it to the unit.
2. Be sure to connect AC wires with the correct polarity. If the L and N wires are connected in reverse, it may cause a short circuit in the utility program.
3. Appliances such as air conditioner are required at least 2~3 minutes to restart because it's required to have enough time to balance refrigerant gas inside of circuits. If a power shortage occurs and recovers in a short time, it will cause damage to your connected appliances. To prevent this kind of damage, please check manufacturer of air conditioner if it's equipped with time-delay function before installation. Otherwise, this inverter/charger will trig overload fault and cut off output to protect your appliance but sometimes it still causes internal damage to the air conditioner.

2.3.3 PV Connection

CAUTION: Before connecting to PV modules, Disconnect the PV circuit breaker first.

WARNING! All wiring must be performed by a qualified personnel.

WARNING! It's very important for system safety and efficient operation to use appropriate cable for PV module connection. To reduce risk of injury, please use the proper recommended cable size as below.

Typical Amperage	Cable Size	Torque Value
27A	10AWG	1.2 ~ 1.6 Nm

PV Module Selection:

1. Open circuit Voltage (Voc) of PV modules not exceeds max. PV array open circuit voltage of inverter.
2. Open circuit Voltage (Voc) of PV modules should be higher than min. battery voltage.
3. Max. Power Voltage (Vmpp) of PV modules should be close to best Vmp of inverter or within Vmp range to get best performance. If one PV module can not meet this requirement, it's necessary to have several PV modules in series connection.

3. Guidance for battery inspection upon reception

- Cartons that have been crushed, punctured, or torn in such a way that contents are revealed shall be set aside in an isolated area and inspected by a skilled person. If the package is deemed to be not shippable, the contents shall be promptly collected, segregated, and either the consignor or consignee contacted.
- Batteries are shipped with half charge. Batteries shall never be transported while the battery is energized.
- A precautionary label had been affixed to the shipping carton to alert individuals as to the battery within the package have been disconnected, otherwise, the battery should not be transported.
- We have conducted comprehensive tests to ensure the equipment is safe for transport. These products shall be handled with care and immediately inspected if visibly damaged. if the carton is visibly damaged, please contact your distributor to confirm whether the battery could be used safely or not.

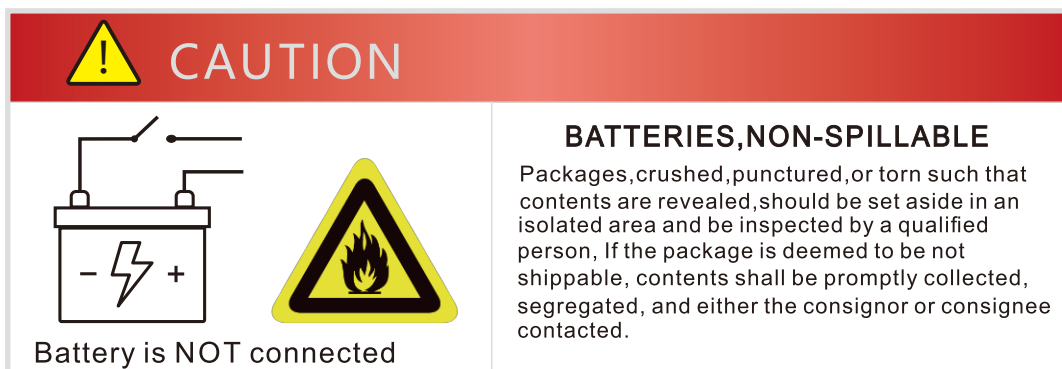

4. Installation Pre-requisites







4.1 Selection of installation sites

- A. System working temperature range: 0°C ~ 50°C; Optimum temperature: 18°C ~ 28 °C. Do not place the battery system in direct sun light. It is suggested to build sunshade equipment In cold area the heating system is required.
- B. System must not be immersed in water. Cannot be placed the battery base in rain or other water sources.
- C. System is only rated for IP20 uses, Outdoor installations are expressly forbidden.
- D. System ventilation is important, never install the batteries in a sealed enclosure without adequate ventilation.
- E. Never install near flammable or explosive materials.
- F. Minimal dust and dirt in the area. Excessive dust ingress into the batteries will accumulate and damage sensitive electrical equipment.
- G. No corrosive gases present, including ammonia and acid vapors.

If the ambient temperature is outside the operating range, battery will protect itself by shutting down. Frequent exposure to severe operating condition will reduce the performance and lifetime of the battery.

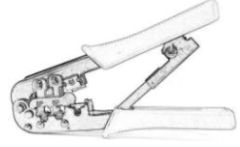
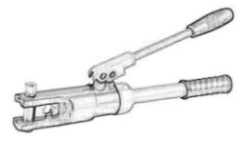
4.2 Tools

The following tools are required to install the battery pack:

			
Phillips screwdriver	Torque wrench	Cable crimper	Wire clamp
			
Voltmeter	Tape measure	Drill	Flat-head screwdriver

NOTE

Use properly insulated tools to prevent accidental electric shock or short circuits. If insulated tools are not available, cover the entire exposed metal surfaces with available insulated alternatives, except their tips, with electrical tape.

4.3 Personal protective equipment

It is recommended to wear the following safety gear when dealing with the battery pack.

		
Insulated glove	Safety goggles	Safety shoes

4.4 Storage

If the battery is not to be installed immediately or removed from operation and needs to be stored for a long period, please choose an appropriate location to store it. Instructions for storage are:

- A. The temperature of battery stored recommended in the range of -20°C to 25°C.
- B. Do not expose to water.
- C. Single battery module is 48.5kg. If without handling tools must have more than 2 men to handling with it.
- D. The battery box should be upright and not stacked upside down when storing the battery.





For long-term storage (more than 3 months), the battery cells should be stored in the temperature range of 5~45 °C , relative humidity <65% and contains no corrosive gas environment.

The battery module should shelved in range of 5~45°C , dry, clean and well ventilated environment. Before storage the battery should be charged to 50-55% SOC.

it is recommended to active the chemical (discharge and charge) of the battery every 3 months, and the longest discharge and charge interval shall not exceed 6 months.

5. Battery Installation

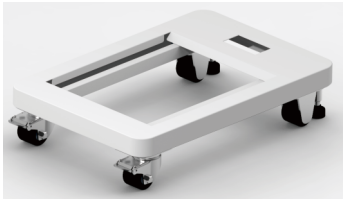
5.1 Package Items

		
Battery Inverter*1	Battery Module*1	USB Cable*1
		
Battery Base*1	Data Cable *1	USER Manual *1

5.2 Checks before installation

There are a few things to check before installing the battery to ensure that it has no defects.

Check item : Check the battery voltage

1. If this checking process is executed for any reason after the battery is installed, make sure that the inverter is turned off or open the connection between battery and inverter while checking the battery.
2. Turn on the switch of the battery module, and the function light will cycle. Measure the voltage at the battery terminals with a voltmeter. If the voltage is lower than 48V it will require to be recharged prior to installation. Contact distributor for this. New batteries are shipped with in between 52-53VDC.

5.3 Installation of battery base

1. The base should be placed on a flat ground.
2. Press the brake switch of the universal wheel and adjust the support foot of the directional wheel to support it to the ground.

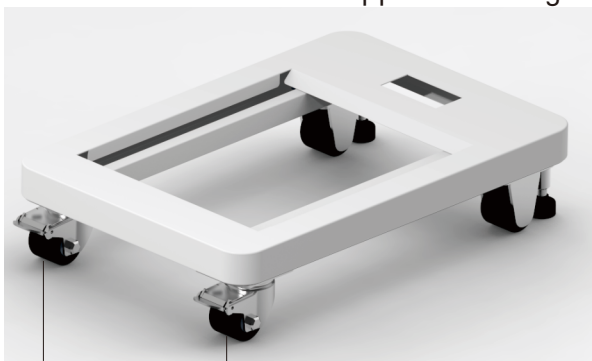

Brake universal wheel

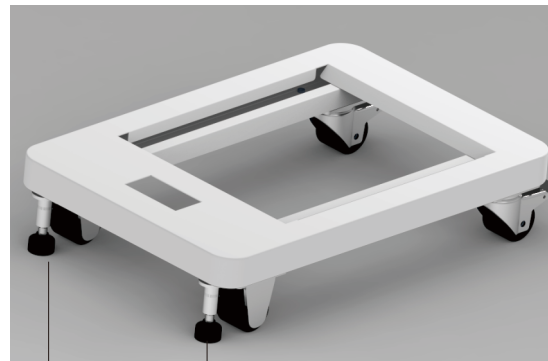

Directional wheel with supporting feet

5.4 Battery Modules and Inverter Module pile up

Assembly of battery module and battery base:

The protrusion at the bottom of the battery module is assembled into the groove of the battery base

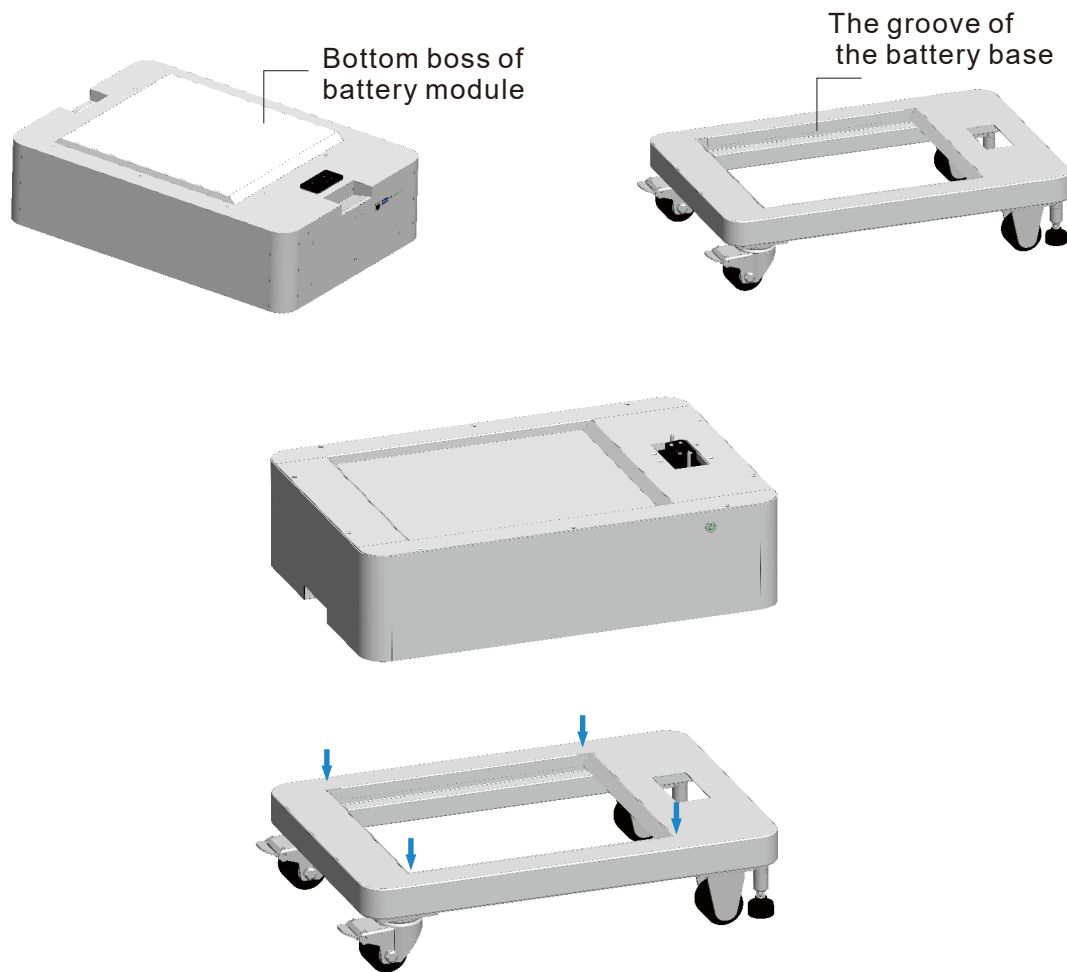

Assembly between battery modules:

1. Assemble the bottom boss of the previous layer of battery module to the top groove of the next layer of battery module.
2. And the connector 1 of the next module is inserted into the connector 2 of the previous module.

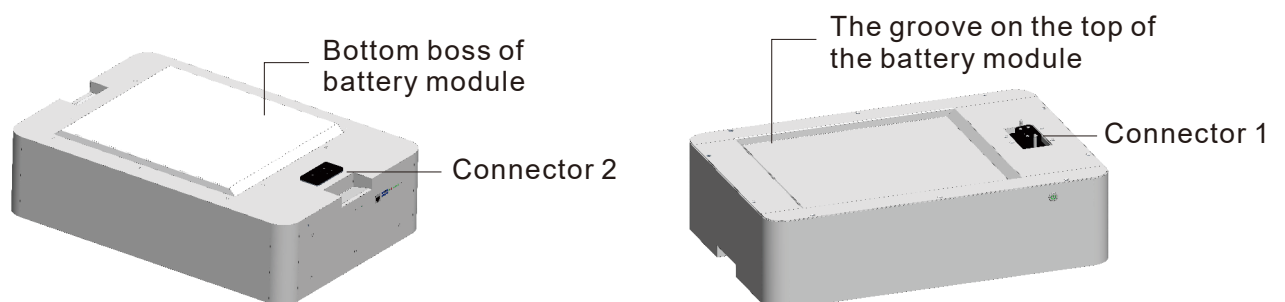

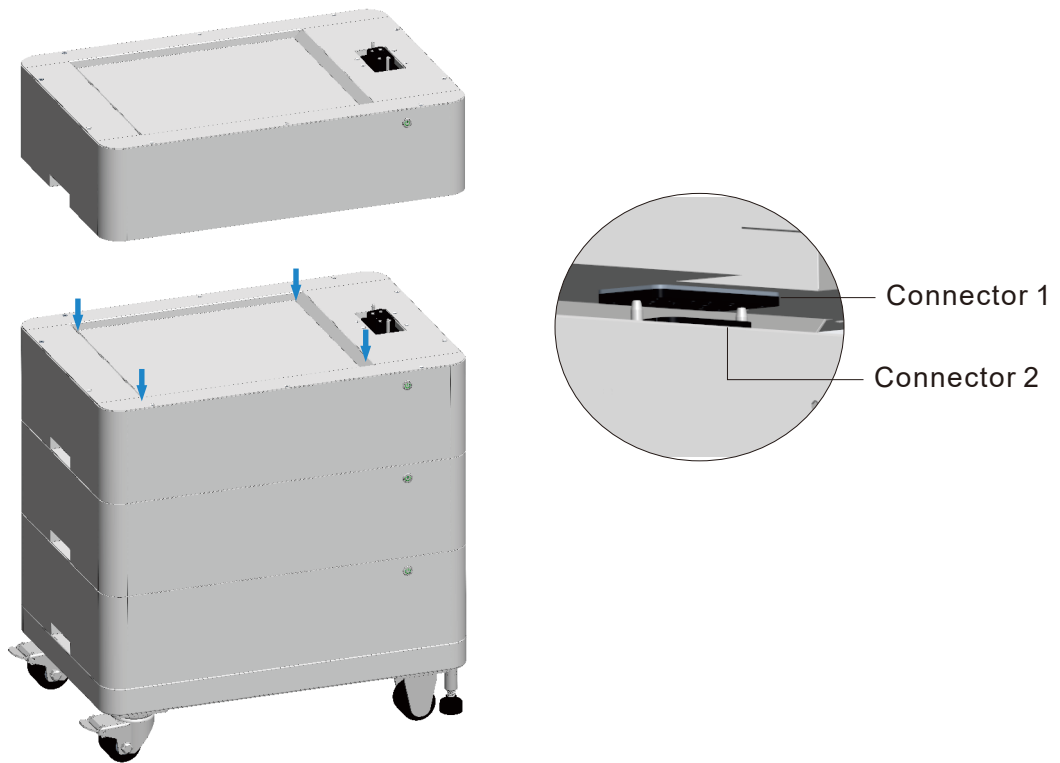

Assembly of battery inverter and battery modules

1. The bottom boss of the battery inverter is assembled into the top groove of the battery module.
2. At the same time, connector 1 of the battery module is inserted into the connector of the battery inverter.

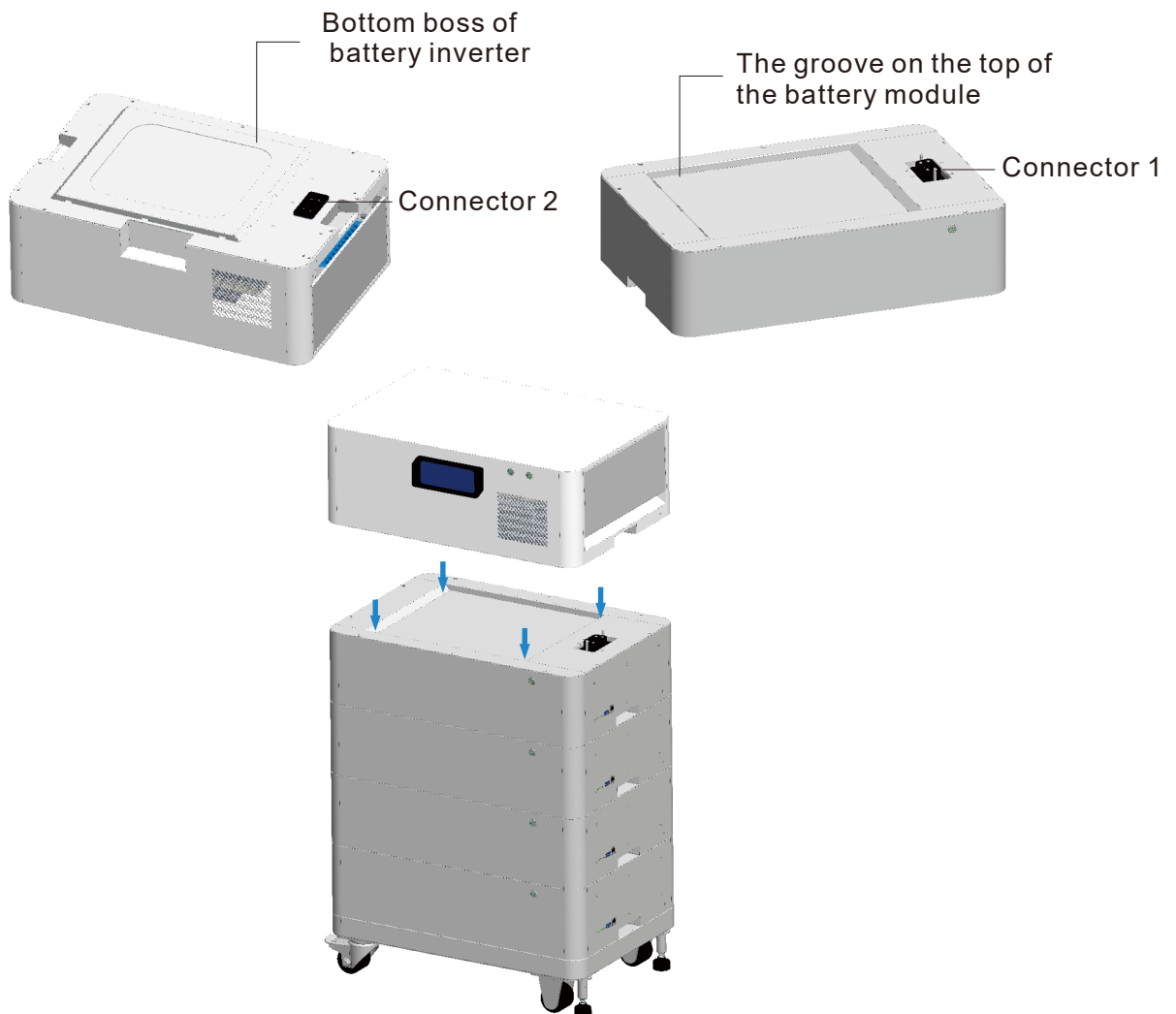

5.5 Grounding

NOTICE



Earthing shall be connected from Inverter to battery and in between batteries for multi-battery systems.

Grounding cable must ≥ 10 AWG. The cable shall be copper with yellow-green color.

6. System Operations

6.1 Master Slave - Battery Dip Switches Configuration

The battery system employs a master slave configuration for data capture and communication to the Inverter system. Each battery module comes with an 8-digit dip switch board, which is used to define the function (Master/Slave) of the battery. The switch board also defines Slave ID of each battery and the total number of slaves on the system. The system allows 1 x Master and 15 x Slaves per battery clusters.



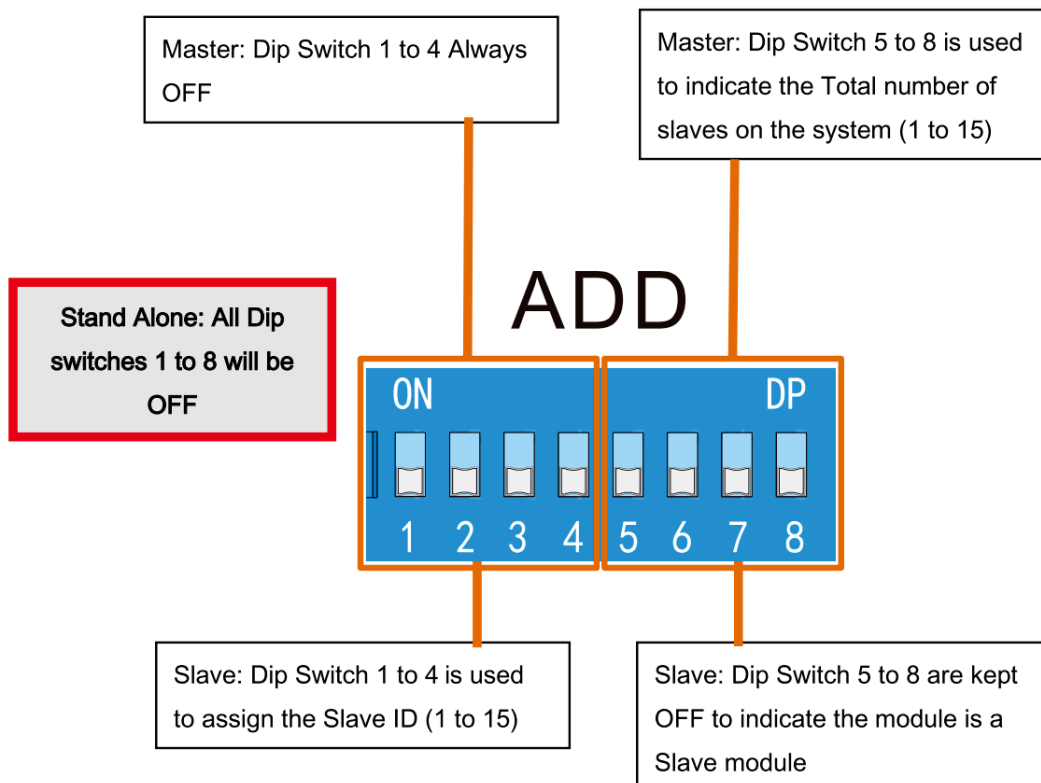













Multiple clusters are possible with the usage of an external communication BMS Master and Slaves have different Dip Switches configuration which can be found at its respective sections.



6.1.1 Master Batteries Dip Switch Configuration

Dip Switches 1 to 4: First 4 Dip Switches (1 to 4) will be kept OFF to designate the module as a Master batteries. Please note that only the master module communicates to the inverter via the CAN port.















Dip Switches 5 to 8: last 4 Dip Switches (5 to 8) are used to indicate the number of slaves on the system. I.e: for a system with 4 batteries there will be 1xMaster and 3xSlaves batteries. Therefore, the last 4 digits must be set accordingly to 3 Slaves as per the example table below.

Total # of Batteries Modules	Total # of Slaves Batteries Modules	Master Battery Module Dip Switch Configuration	Total # of Batteries Modules	Total # of Slaves Batteries Modules	Master Battery Module Dip Switch Configuration
1	0		9	8	
2	1		10	9	
3	2		11	10	
4	3		12	11	
5	4		13	12	
6	5		14	13	
7	6		15	14	
8	7		16	15	

6.1.2 Slave Batteries Dip Switch Configuration

Dip Switches 1 to 4: First 4 Dip Switches (1 to 4) will be used to indicate the slave number from slave 1 to slave 15 as per the table below.







Dip Switches 5 to 8: last 4 Dip Switches (5 to 8) are used to indicate that the battery is an slave, all 4 dip switches must be in the off position as indicated on the table below.

Slaves Identity	Slave Battery Module Dip Switch Configuration	Slaves Identity	Slave Battery Module Dip Switch Configuration
0	N/A	8	
1		9	
2		10	
3		11	
4		12	
5		13	
6		14	
7		15	

6.2 LED indication function

The battery module has 6 LED indicators, 4 green indicators indicate the battery module SOC (25% intervals), 1 red indicator used for fault/Alarm indication, and 1 green operation lamp used to indicate standby, charging and discharging status of the battery pack.

Note: alarm refers to the following categories: the Cell voltage difference is too large, the SOC capacity is low, the cell voltage is low, the over all group voltage is low, charging over current, discharge over current, core temperature is high, ambient temperature is low, ambient temperature is high, and the BMS MOS section over temperature.

System state	Protection alarm / normal	RUN	ALM	LED Indicator			
							
Shut down	Sleep Mode	OFF	OFF	ALL OFF			
Standby	Normal	Flash1	OFF	ALL OFF			
	Alarm condition	Flash3	OFF				
Charge	Normal	NO	OFF	According to SOC Maximum LED flash 2)			
	Over voltage alarm	OFF	ON				
	Over current alarm	ON	Flash3	According to SOC			
	Over voltage protection	ON	OFF	Solid ON			
	Over current	OFF	Solid ON	ALL OFF			

	protection(when the function of infinite current)			
	Current limiting charging	Solid ON	OFF	According to SOC
Discharge	Normal	Flash3	OFF	According to SOC
	Alarm condition	Flash3	Flash3	
	Protection of overcurrent, short circuit, reverse connection, etc.	OFF	Solid ON	ALL OFF
Temperature	Charging alarm	ON	Flash3	According to SOC
	Discharge alarm	Flash3	Flash3	
	protection	OFF	ON	ALL OFF

6.3 System turns on

1. Check all cables are connected correctly. Check grounding is connected.
2. Turn on the power switch of the battery module, the button light will light up, and the function light of the battery module will light up once. Wait for 5 seconds for the system to self check before proceeding to the next step of operation
3. Open the protective wire cover of the battery inverter, open the battery circuit breaker, and wait for 10 seconds for the system to self check.
4. Turn on the inverter power switch, the inverter will sound a sound, wait for 10 seconds for the inverter to self check, and the "AC/INV" light will flash in standby mode The system is working properly.

6.4 System output mode

Battery inverter output mode

After starting the system, open the AC output circuit breaker to output AC power.

Grid power supply mode

After starting the system, open the AC input circuit breaker, wait for 10 seconds for the inverter mode to switch, and then open the AC output circuit breaker to output AC power

Automatic switching of output mode

When the system is in grid power supply mode for output, it automatically switches to battery inverter output mode when there is no grid power supply during maintenance. When the grid is normal, it automatically switches to grid power supply mode

6.5 Battery charging

Charging using the power grid

Open the AC input circuit breaker and wait for 10 seconds. When the system detects that the battery needs to be charged, it automatically switches to charging mode. The charging indicator light "CHG" lights up, and the system starts charging the battery.

Using PV charging

A: Using PV1 charging:

Open the PV1 circuit breaker and wait for 10 seconds. When the system detects that the battery needs to be charged, it automatically switches to charging mode. The charging indicator light "CHG" lights up, and the system starts charging the battery.

B: Using PV2 charging:

Turn on the PV2 power switch, the switch light will light up, wait for 10 seconds for the system to self check, then turn on the PV2 circuit breaker. When the system detects that the battery needs to be charged, it will automatically switch to charging mode, and the charging indicator light CHG will light up. The system will start charging the battery.

C: Can be charged simultaneously using PV1 and PV2

6.6 Battery inverter operation

Operation and Display Panel

The operation and display panel, shown in below chart, is on the front panel of the inverter. It includes three indicators, four function keys and a LCD display, indicating the operating status and input/output power information.

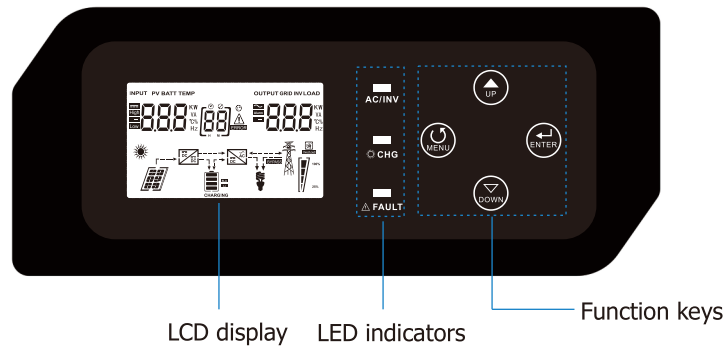

LED Indicator

LED Indicator		Messages	
AC/ INV	Green	Solid On	Output is powered by grid in Line mode.
		Flashing	Output is powered by battery or PV in battery mode.
CHG	Yellow	Flashing	Battery is charging or discharging.
FAULT	Red	Solid On	Fault occurs in the inverter.
		Flashing	Warning condition occurs in the inverter.

Function Keys

Function Keys	Description
MENU	Enter reset mode or setting mode go to previous selection.
UP	Increase the setting data.
DOWN	Decrease the setting data.
ENTER	Enter setting mode and Confirm the selection in setting mode go to next selection or exit the reset mode.



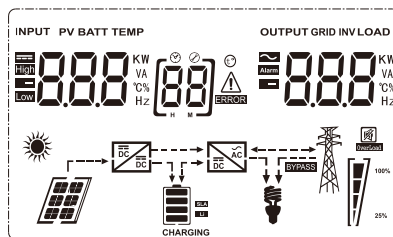









LCD Display Icons









Icon	Function description
Input Source Information and Output Information	
	Indicates the AC information
	Indicates the DC information
	Indicate input voltage, input frequency, PV voltage, battery voltage and charger current. Indicate output voltage, output frequency, load in VA, load in Watt and discharging current.
Configuration Program and Fault Information	
	Indicates the setting programs
	Indicates the warning and fault codes. Warning: flashing with warning code. Fault: lighting with fault code.

Battery Information





	Indicates battery level by 0-24%, 25-49%, 50-74% and 75-100% in battery mode and charging status in line mode.	
In AC mode, it will present battery charging status.		
Status	Battery voltage	LCD Display
Constant Current mode/Constant Voltage mode	<2V/cell	4 bars will flash in turns
	2v/cell~2.083v/cell	Bottom bar will be on and the other three bars will flash in turns.
	2.083v/cell~2.167v/cell	Bottom two bars will be on and the other two bars will flash in turns.
	>2.167V/cell	Bottom three bars will be on and the top bar will flash.
Batteries are fully charged.		4 bars will be on.

In battery mode, it will present battery capacity.		
Load Percentage	Battery Voltage	LCD Display
Load >50%	<1.717V/cell	
	1.717V/cell~1.8V/cell	
	1.8V/cell~1.883V/cell	
	>1.883 V/cell	
50%> Load>20%	<1.817V/cell	
	1.817V/cell~1.9V/cell	
	1.9 V/cell ~1.983V/cell	
	>1.983 V/cell	
Load<20%	<1.867V/cell	
	1.867V/cell~1.95V/cell	
	1.95V/cell~2.033V/cell	
	>2.033 V/cell	

Load Information

	Indicates overload.			
	Indicates the load level by 0-24%, 25-49%, 50-74% and 75-100%.			
	0%~24%	25%~49%	50%~74%	75%~100%
				

Mode Operation Information

	Indicates unit connects to the mains.
	Indicates unit connects to the PV panel.
	Indicates load is supplied by utility power.
	Indicates the solar charger circuit is working.
	Indicates the DC/AC inverter circuit is working.



Mute Operation

	Indicates unit alarm is disabled.
---	-----------------------------------

LCD Setting

After pressing and holding "ENTER" button for 2 seconds, the unit will enter setting mode. Press "UP" or "DOWN" button to select setting programs. And then, press "ENTER" or "MENU" button to confirm the selection and exit.

Setting Programs:

Program	Description	Selectable option	
00	Exit setting mode	Escape 	
01	Output source priority selection	(default) 	Solar energy provides power to the loads as first priority, If solar energy is not sufficient to power all connected loads, Utility energy will supply power to the loads at the same time. The battery energy will supply power to the load only in the condition of the utility is unavailable. If the solar is unavailable, the utility will charge the battery until the battery voltage reaches the setting point in program 21.If the solar is available, but the voltage is lower than the setting point in program 20, the utility will charge the battery until the battery voltage reaches the setting point in program 20 to protect the battery from damage.
			Solar energy provides power to the loads as first priority, If solar energy is not sufficient to power all connected loads, battery energy will supply power to the loads at the same time. Utility provides power to the loads only when battery voltage drops to either low-level warning voltage or the setting point in program 20 or solar and battery is not sufficient. The battery energy will supply power to the load in the condition of the utility is unavailable or the battery voltage is higher than the setting point in program 21(when BLU is selected) or program 20(when LBU is selected). If the solar is available, but the voltage is lower than the setting point in program 20, the utility will charge the battery until the battery voltage reaches the setting point in program 20 to protect the battery from damage.

		[0] SOL	<p>Solar energy provides power to the loads as first priority.</p> <p>If battery voltage has been higher than the setting point in program 21 for 5 minutes, and the solar energy has been available for 5 minutes too, the inverter will turn to battery mode, solar and battery will provide power to the loads at the same time.</p> <p>When the battery voltage drops to the setting point in program 20, the inverter will turn to bypass mode, utility provides power to the load only, and the solar will charge the battery at the same time.</p>
		[0] UT	Utility will provide power to the loads as first priority. Solar and battery energy will provide power to the loads only when utility power is not available.
02	AC input voltage range	Appliances (default) [02] APL	If selected, acceptable AC input voltage range will be within 90-280VAC.
		UPS [02] UPS	If selected, acceptable AC input voltage range will be within 170-280VAC.
		GEN [02] GEN	When the user uses the device to connect the generator, select the generator mode.
		VDE [02] VDE	If selected, acceptable AC input voltage range will conform to VDE4105 (184VAC-253VAC)
03	Output voltage	[03] 230 _v	Set the output voltage amplitude, (220VAC-240VAC)
04	Output frequency	50HZ(default) [04] 50.0 _{Hz}	60HZ [04] 60.0 _{Hz}
05	Solar supply priorit	(default) [05] BLU	<p>Solar energy provides power to charge battery as first priority.</p> <p>When the utility is available, if the battery voltage is lower than the setting point in program 21, the solar energy will never supply to the load, only charge the battery. If the battery voltage is higher than the setting point in program 21, the solar energy will supply to the load or recharge the battery.</p>

		[05] LBU	Solar energy provides power to the loads as first priority. If the battery voltage is lower than the setting point in program 20, the solar energy will never supply to the load, only charge the battery. If the battery voltage is higher than the setting point in program 20, the solar energy will supply to the load or recharge the battery.
06	Overload bypass: When enabled, the unit will transfer to line mode if overload occurs in battery mode.	Bypass disable [06] bYd	Bypass enable(default) [06] bYE
07	Auto restart when overload occurs	Restart disable(default) [07] Lfd	Restart enable [07] LfE
08	Auto restart when over temperature occurs	Restart disable(default) [08] tfd	Restart enable [08] tFE
10	Charger source priority: To configure charger source priority	If this inverter/charger is working in Line, Standby or Fault mode, charger source can be programmed as below:	
		Solar first [10] C50	Solar energy will charge battery as first priority. Utility will charge battery only when solar energy is not available.
		Solar and Utility(default) [10] 5NU	Solar energy and utility will charge battery at the same time.
		Only Solar [10] 050	Solar energy will be the only charger source no matter utility is available or not
		If this inverter/charger is working in Battery mode, only solar energy can charge battery. Solar energy will charge battery if it's available and sufficient.	
11	Maximum charging current: To configure total charging current for solar and utility chargers.(Max. charging current =utility charging current + solar charging current)	60A (default) [1] 60 ^A	Setting range is from 1 A to 120A. Increment of each click is 1A.
		80A (default) [1] 80 ^A	Setting range is from 1 A to 140A. Increment of each click is 1A.
		100A (default) [1] 100 ^A	Setting range is from 1 A to 160A. Increment of each click is 1A.
13	Maximum utility charging current	30A (default) [13] 30 ^A	Setting range is from 1A to 60A. Increment of each click is 1A.

14	Battery type	AGM (default) [14] AGM	Flooded [14] FLD
		GEL [14] GEL	LEAD [14] LEA
		Lithium Ion [14] L	User-Defined [14] USE
		If "User-Defined" LI is selected, battery charge voltage and low DC cut-off voltage can be set up in program 17, 18 and 19.	
17	Bulk charging voltage (C.V voltage)	24V model default setting: 28.2V [17] CV 28.2 ^v	If "User-Defined" LI is selected in program 14, this program can be set up. Setting range is from 24.0V to 29.2V for 24Vdc model. Increment of each click is 0.1V.
		48V model default setting: 56.4V [17] CV 56.4 ^v	If "User-Defined" LI is selected in program 14, this program can be set up. Setting range is from 48.0V to 58.4V for 48Vdc model. Increment of each click is 0.1V.
		24V model default setting: 27.0V [18] FLV 27.0 ^v	If "User-Defined" LI is selected in program 14, this program can be set up, Setting range is from 24.0V to 29.2V for 24Vdc model. Increment of each click is 0.1V.
		48V model default setting: 54.0V [18] FLV 54.0 ^v	If "User-Defined" LI is selected in program 14, this program can be set up, Setting range is from 48.0V to 58.4V for 48Vdc model. Increment of each click is 0.1V.
18	Floating charging voltage	24V model default setting: 20.4V [19] COV 20.4 ^v	If "User-Defined" LI is selected in program 14, this program can be set up. Setting range is from 20.0V to 24.0V for 24Vdc model. Increment of each click is 0.1V. Low DC cut-off voltage will be fixed to setting value no matter what percentage of load is connected.
		48V model default setting: 40.8V [19] COV 40.8 ^v	If "User-Defined" LI is selected in program 14, this program can be set up. Setting range is from 40.0V to 48.0V for 48Vdc model. Increment of each click is 0.1V. Low DC cut-off voltage will be fixed to setting value no matter what percentage of load is connected.

20	Battery stop discharging voltage when grid is available	Available options for 24V models:	
		23.0V (default) [20] 230 _v	Setting range is from 22.0V to 29.0V. Increment of each click is 0.1V.
		Available options for 48V models:	
		46.0V (default) [20] 460 _v	Setting range is from 44.0V to 58.0V. Increment of each click is 0.1V.
21	Battery stop charging voltage when grid is available	Available options for 24V models:	
		27.0V (default) [21] 270 _v	Setting range is from 22.0V to 29.0V. Increment of each click is 0.1V.
		Available options for 48V models:	
		54.0V (default) [21] 540 _v	Setting range is from 44.0V to 58.0V. Increment of each click is 0.1V.
22	Auto turn page	(default) [22] PLE	If selected, the display screen will auto turn the display page.
		[22] Pld	If selected, the display screen will stay at latest screen user finally switches.
23	Backlight control	Backlight on [23] LOn	Backlight off (default) [23] LOF
24	Alarm control	Alarm on (default) [24] bOn	Alarm off [24] bOF
25	Beeps while primary source is interrupted	Alarm on [25] aOn	Alarm off (default) [25] aOF
27	Record Fault code	Record enable(default) [27] FOn	Record disable [27] FOF
28	Solar power balance: When enabled, solar input power will be automatically adjusted according to connected load power.	Solar power balance enable [28] 5bE	If selected, the solar input power will be automatically adjusted according to the following formula: Max. Input solar power = Max.battery charging power + Connected load power when the machine in OffGrid workstate.
		Solar power balance disable (default) [28] 5bd	If selected, the solar input power will be the same to max. Battery charging power no matter how much loads are connected. The max.battery charging power will be based on the setting current in program 11 (Max. solar power = Max.battery charging power)













29	Power saving mode enable/ disable	Saving mode disable (default) [29] 5d5	If disable, no matter connected load is low or high, the on/off status of inverter output will not be effected.
		Saving mode enable [29] 5e7	If enable, the output of inverter will be off when connected load is pretty low or not detected.
30	Battery equalization	Battery equalization [30] Ee7	Battery equalization disable(default) [30] Ed5
31	Battery equalization voltage	Available options for 24V models:28.8V [31] E4 28.8 ^v	
		Available options for 48V models:57.6V [31] E4 57.6 ^v	
		Setting range is from 24.0V to 29.2V for 24V model and 48.0V to 58.4V for 48V model. Increment of each click is 0.1V.	
33	Battery equalization time	60min(default) [33] 60	Setting range is from 5 min to 900min. Increment of each click is 5min.
34	Battery equalization timeout	120min(default) [34] 120	Setting range is from 5 min to 900min. Increment of each click is 5min.
35	Equalization interval	30days(default) [35] 30d	Setting range is from 0 to 90days. Increment of each click is 1 day.
36	Equalization activated immediately	Enable [36] Aee7	Disable(default) [36] Ad5
		If equalization function is enabled in program 30, this program can be set up. If "Enable" is selected in this program, it's to activate battery equalization immediately and LCD main page will show "E9". If "Disable" is selected, it will cancel equalization function until next activated equalization time arrives based on program 35 setting. At this time, "E9" will be shown in LCD main page too.	
37	BMS control method	Voltage method(default) [37] 40L	SOC Percent method [37] 50C
38	Battery stop discharging percent When SOC is available	20 % (default) [38] 20 %	Setting range is from 20 % to 100 % Increment of each click is 1 % .
39	Battery stop charging percent When SOC is available	95 % (default) [39] 95 %	Setting range is from 20 % to 100 % Increment of each click is 1 % .



















40	BMS communication	(default) [40] .dP	when the communication between BMS and converter is faulted ,the converter still charge or discharge from the battery
		[40] Un1	when the communication between BMS and converter is faulted ,the converter stop charging or discharging from the battery

After pressing and holding "MENU" button for 6 seconds, the unit will enter reset model. Press "UP" and "DOWN" button to select programs. And then, press "ENTER" button to exit.



SEt	(default) [dt] nHt	Reset setting disable
	[dt] tSt	Reset setting enable

Fault Reference Code

Fault Code	Fault Cause	LCD Indication
01	Fan is locked when inverter is off	[01] 
02	Inverter transformer over temperature	[02] 
03	Battery voltage is too high	[03] 
04	Battery voltage is too low	[04] 
05	Output short circuited	[05] 
06	Inverter output voltage is high	[06] 
07	Overload time out	[07] 
08	Inverter bus voltage is too high	[08] 
09	Bus soft start failed	[09] 
11	Main relay failed	[11] 
21	Inverter output voltage sensor error	[21] 
22	Inverter grid voltage sensor error	[22] 
23	Inverter output current sensor error	[23] 

24	Inverter grid current sensor error	[24] 
25	Inverter load current sensor error	[25] 
26	Inverter grid over current error	[26] 
27	Inverter radiator over temperature	[27] 
31	Solar charger battery voltage class error	[31] 
32	Solar charger current sensor error	[32] 
33	Solar charger current is uncontrollable	[33] 
41	Inverter grid voltage is low	[41] 
42	Inverter grid voltage is high	[42] 
43	Inverter grid under frequency	[43] 
44	Inverter grid over frequency	[44] 
51	Inverter over current protection error	[51] 
52	Inverter bus voltage is too low	[52] 
53	Inverter soft start failed	[53] 
55	Over DC voltage in AC output	[55] 
56	Battery connection is open	[56] 
57	Inverter control current sensor error	[57] 
58	Inverter output voltage is too low	[58] 

Warning Indicator

Warning Code	Warning Event	Icon flashing
61	Fan is locked when inverter is on.	[61] 
62	Fan 2 is locked when inverter is on.	[62] 
63	Battery is over-charged.	[63] 

64	Low battery	
67	Overload	
70	Output power derating	
72	Solar charger stops due to low battery	
73	Solar charger stops due to high PV voltage	
74	Solar charger stops due to over load	
75	Solar charger over temperature	
76	PV charger communication error	
77	Parameter error	

Operating State Description

Operating State	Description	LCD display
Match load state Note: DC power produced from your solar array is converted by the inverter into AC power, which is then sent to your main electrical panel to be used by your household appliances. Any excess power generated is not sold back to the grid, but stored in battery.	PV energy is charger into the battery or converted by the inverter to the AC load	PV energy power is larger than inverter power
		PV energy power is smaller than inverter power
		PV is off
Charge state	PV energy and grid can charge batteries.	
Bypass state	Error are caused by inside circuit error or external reasons such as over temperature, output short circuited and so on.	

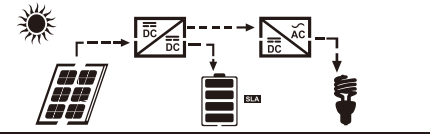
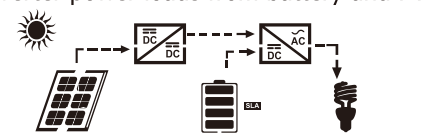
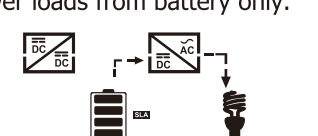
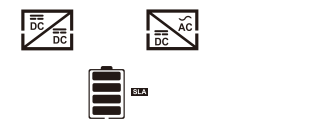
Off-Grid state	The inverter will provide output power from battery and PV power.	Inverter power loads from PV energy. 
		Inverter power loads from battery and PV energy. 
		Inverter power loads from battery only. 
Stop mode	The inverter stop working if you turn off the inverter by the soft key or error has occurred in the condition of no grid.	

Display Setting

The LCD display information will be switched in turns by pressing "UP" or "DOWN" key. The selectable information is switched as below order: battery voltage, battery current, inverter voltage, inverter current, grid voltage, grid current, load in Watt, load in VA, grid frequency, inverter frequency, PV voltage, PV charging power, PV charging output voltage, PV charging current.

Selectable information	LCD display	
Battery voltage/DC discharging current	^{BATT} 52.0 _v	48.0 _A
Inverter output voltage/Inverter output current	229 _v	^{INV} 13.0 _A
Grid voltage/Grid current	229 _v	^{GRID} 8.0 _A
Load in Watt	1.00 ^{KW}	1.20 ^{LOAD} _{VA}
Grid frequency/Inverter frequency	^{INPUT} 50.0 _{Hz}	^{INV} 50.0 _{Hz}
PV voltage and power	^{PV} 12.0 _v	2.00 ^{KW}
PV charger output voltage and PV charging current	^{PV} 5.10 _v	^{OUTPUT} 4.00 _A